

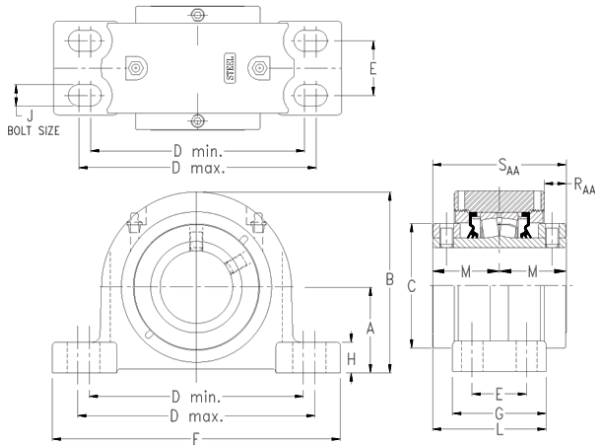

DGB BEARING IMPORTED LTD



timken QAAPF13A065S Solid Block/Spherical Roller Bearing Housed Units-Double Concentric Four-Bolt Pillow Block

Bearing No. QAAPF13A065S

Engineering Group	Mounted Bearing
Shaft Size	65 mm
Shaft Size Type	Metric
Full Timken Part Number	QAAPF13A065SB
Locking Style	Double Concentric
Weight	20 lb
Housing Style	Four-Bolt Pillow Block
UPC Code	0883450026802
Dimension A	2.75 in
Dimension B	5.8 in
Dimension C	3.81 in
Dimension D Max	7.63 in
Dimension D Min	6.88 in
Dimension E	1.75 in
Dimension F	9.250 in
Dimension G	3.0000 in
Dimension H	0.98 in
Dimension J (Bolt Size)	0.625 in
Dimension L	3.65 in
Dimension M	2.15 in
Dimension RAA	0.70 in
Dimension SAA	4.3 in
C0 - Static Load	48600 lb
C - Dynamic Load (Basic)	46400 lb
e - Geometry Factor	0.24

QAAPF13A065S Bearing 2D drawings and 3D CAD models



DGB BEARING IMPORTED LTD

Y1 - Geometry Factor	2.79
Y2 - Geometry Factor	4.15
Oil Lubrication - M/N Seal	1800 rpm
Oil Lubrication - T Seal	3200 rpm
Oil Lubrication - B/C/O Seal	1500 rpm
Grease Lubrication - M/N Seal	1800 rpm
Grease Lubrication - T Seal	2800 rpm
Grease Lubrication - B/C/O Seal	1500 rpm
Float	0.083 in
Shaft Tolerance	0.0015 in
Eng Internal Radial Clearance - Min	0.0016
Eng Internal Radial Clearance - Max	0.0026
Pre Install Clearance Min	0.0016 in
Pre Install Clearance Max	0.0026 in